

RCJ

- 50 0. 015A 90% , , - 10
- 0. 015A
- 3. 20A
- a DC48V 1. 5W DC110V 3W DC220V 5. 5W
- b 3. 2A 1. 5W
- 5 10s

RCJ - 3

ZC- 23/A

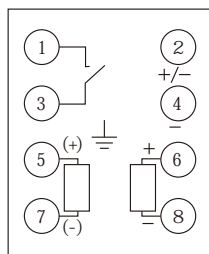

RCJ- 2

2 RCJ

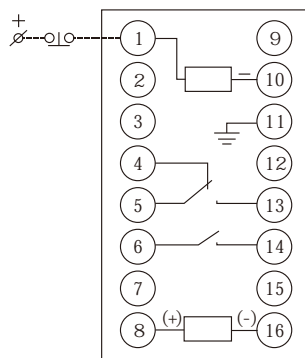

RCJ- 3

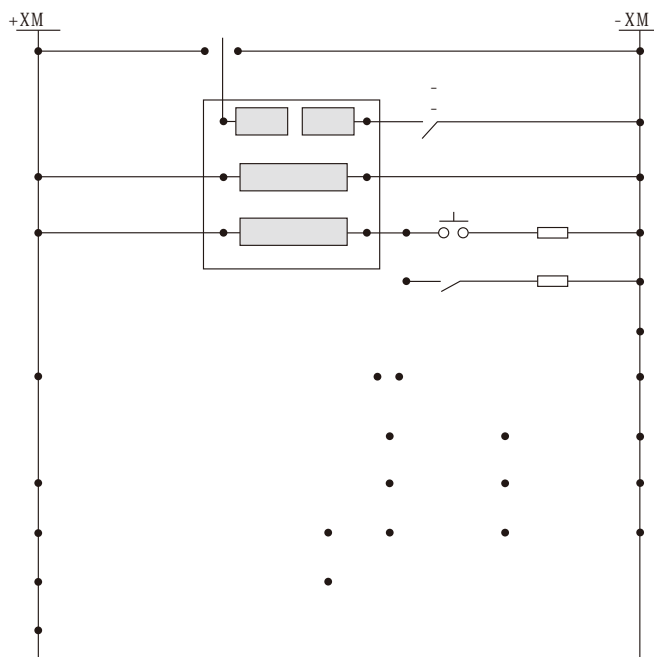

110V

3K/ 10W 5K/ 10W 220V

6K/ 20W 10K/ 20W





RCJ- 2 A11K A11Q

1

RCJ- 3 JK- 2K JK- 2Q

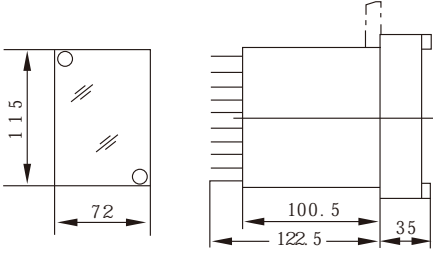
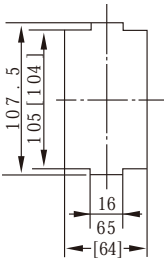
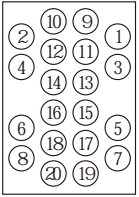
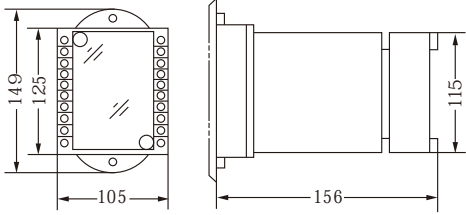
2

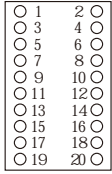
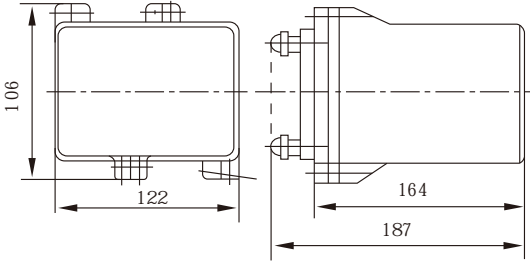
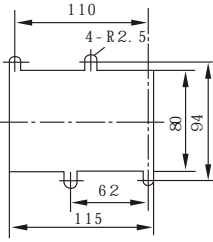
mm

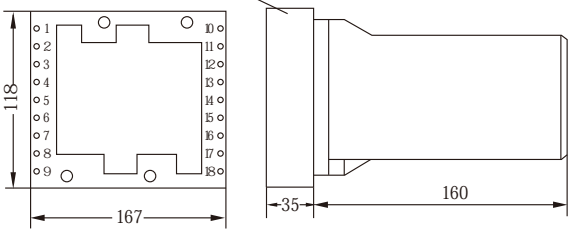
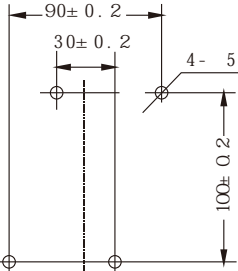
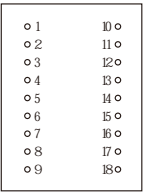
1 A11K (JK-11K)			
1 A11Q JK-11Q			
2 JK-2K			
2 JK-2Q			

ABOUT US
JUREN POWER

1999

